

2- & 3-WAY INTRINSICALLY SAFE VALVES

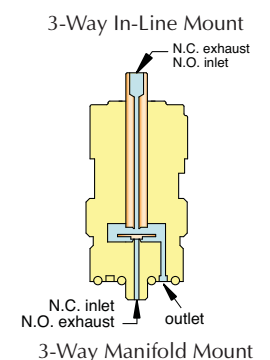

2-WAY INTRINSICALLY SAFE NORMALLY-CLOSED VALVES, IN-LINE & MANIFOLD MOUNT

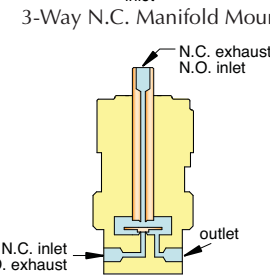
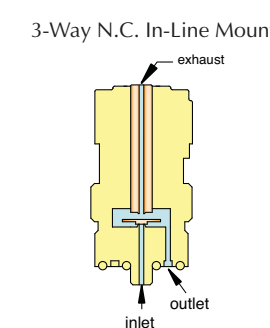
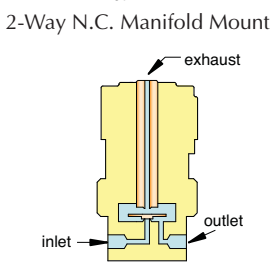
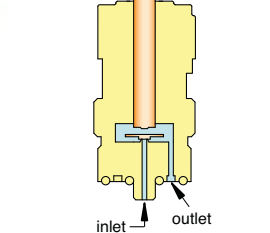
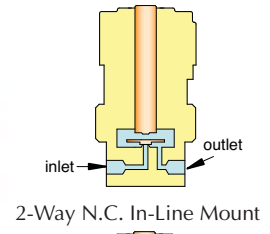
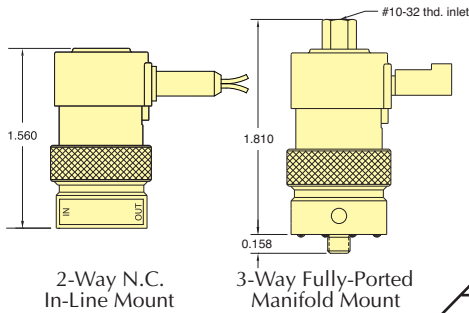

| Pressure Range | Part No. | |
|------------------|------------------------------|-------------------------------|
| | In-Line Mount | Manifold Mount |
| Vac. to 105 psig | EI-2-15.5 | EI-2M-15.5 |
| | EI-2-15.5-L | EI-2M-15.5-L |
| | EI-2-15.5-H | EI-2M-15.5-H |
| Vac. to 50 psig | EI-2-15.5-C | EI-2M-15.5-C |
| | EI-2-15.5-LC | EI-2M-15.5-LC |
| | EI-2-15.5-HC | EI-2M-15.5-HC |
| Vac. to 25 psig | EI-2-15.5-C | EI-2M-15.5-C |
| | EI-2-15.5-LC | EI-2M-15.5-LC |
| | EI-2-15.5-HC | EI-2M-15.5-HC |

3-WAY INTRINSICALLY SAFE NORMALLY-CLOSED VALVES, IN-LINE & MANIFOLD MOUNT

| Pressure Range | Part No. | |
|------------------|------------------------------|-------------------------------|
| | In-Line Mount | Manifold Mount |
| Vac. to 105 psig | EI-3-15.5 | EI-3M-15.5 |
| | EI-3-15.5-L | EI-3M-15.5-L |
| | EI-3-15.5-H | EI-3M-15.5-H |
| Vac. to 50 psig | EI-3-15.5-C | EI-3M-15.5-C |
| | EI-3-15.5-LC | EI-3M-15.5-LC |
| | EI-3-15.5-HC | EI-3M-15.5-HC |
| Vac. to 25 psig | EI-3-15.5-C | EI-3M-15.5-C |
| | EI-3-15.5-LC | EI-3M-15.5-LC |
| | EI-3-15.5-HC | EI-3M-15.5-HC |

3-WAY INTRINSICALLY SAFE FULLY-PORTED VALVES, IN-LINE & MANIFOLD MOUNT

| Pressure Range | Part No. | |
|------------------|-------------------------------|--------------------------------|
| | In-Line Mount | Manifold Mount |
| Vac. to 105 psig | EIO-3-15.5 | EIO-3M-15.5 |
| | EIO-3-15.5-L | EIO-3M-15.5-L |
| | EIO-3-15.5-H | EIO-3M-15.5-H |
| Vac. to 50 psig | EIO-3-15.5-C | EIO-3M-15.5-C |
| | EIO-3-15.5-LC | EIO-3M-15.5-LC |
| | EIO-3-15.5-HC | EIO-3M-15.5-HC |
| Vac. to 25 psig | EIO-3-15.5-C | EIO-3M-15.5-C |
| | EIO-3-15.5-LC | EIO-3M-15.5-LC |
| | EIO-3-15.5-HC | EIO-3M-15.5-HC |

- Medium:** Clean, dry air (40 micron filter)
- Power Consumption:** 0.67 watt
- Temperature Range:** 32 to 180°F
- Response:** 5 to 10 milliseconds (nominal)
- Operating Range:** 90 to 150% of rated voltage
- Voltage:** 15.5 VDC
- Ports:** #10-32 and manifold mount



| Pressure Range | Suffix | Air Flow |
|-------------------------|---------|---------------------|
| 28" Hg Vac. to 105 psig | (blank) | 0.6 scfm @ 100 psig |
| 28" Hg Vac. to 50 psig | -L | 0.5 scfm @ 50 psig |
| 28" Hg Vac. to 25 psig | -H | 0.45 scfm @ 25 psig |

See Page 181 for mounting options
 Other seal materials optional
 See www.clippard.com for more information